

PHOTOELECTRIC SENSORS FTQ SERIES NPN/PNP 10 ÷ 30 VDC



COMPACT SIZE 50 x 50 x 18 mm
 PROGRAMMABLE OUTPUT NPN/PNP
 OUTPUT FUNCTION NO + NC
 SENSITIVITY ADJUSTMENT

TECHNICAL CHARACTERISTICS

Dimensions mm

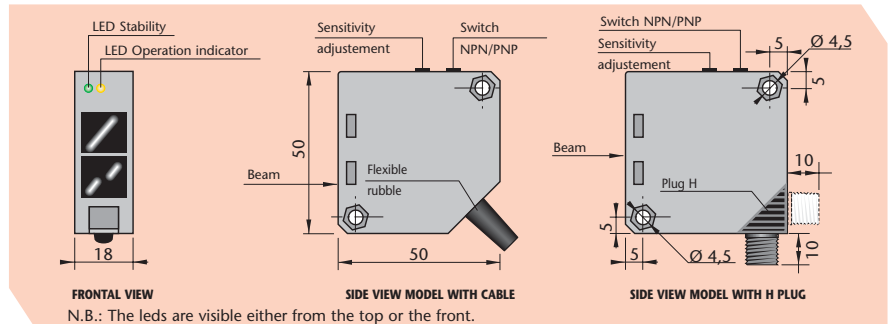

TYPE	REFLECTION			THRU BEAM	
	DIRECT REFLECTION	REFLECTION WITH REFLECTOR	POLARIZED REFLECTION WITH REFLECTOR	RECEIVER	EMITTER
MODEL WITH CABLE	FTQ-CP	FTQ-CR	FTQ-CAR	FTQ-CBR	FTQ-CBE
MODEL WITH H PLUG	FTQ-CP-H	FTQ-CR-H	FTQ-CAR-H	FTQ-CBR-H	FTQ-CBE-H
Sensing range (Sn)	cm	80*	500**	300**	2000
Programmable output	NPN/PNP		NO + NC		
Light source	Led	Infrared	Red	Infrared	
Power on delay	mSec	≤ 80			
Switching frequency	Hz	700	250		
Continuous voltage (Res. ripple ≤10%)	V	10 ÷ 30			
Multivoltage AC/DC	V				
Max output current	mA	200			-
Max current consumption at 24 Vdc	mA	≤ 50	≤ 20		≤ 50
Voltage drop (I out = 200 mA)	V	≤ 3			
Short circuit protection	Incorporated				-
Light immunity	>10.000 Lux				-
Led	Yellow	Operation indicator			Power supply
	Green	Stability control			(Red Led)
Temperature limits	°C	Working temperature: -20 ÷ +50 / Storage temperature: -20 ÷ +65			
Protection degree	IP	65			
Plastic housing	Gray ABS				
Cable	2m	4 x 0.25 mm ²			2 x 0.50 mm ²
Connector plug	H				

WIRING DIAGRAMS

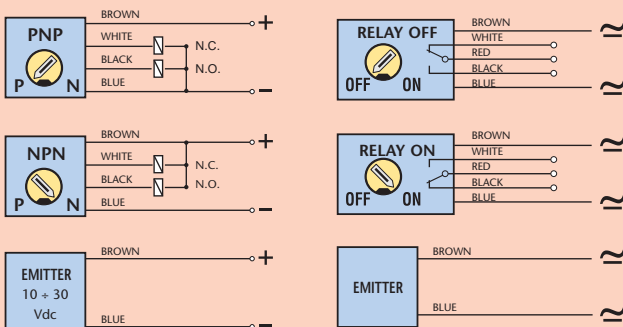

N.B.: On request is available cable for sensors with different length 3.5 - 5 - 7.5 - 10 m.

CONNECTION WHIT H PLUG

FOR THE CONNECTORS SEE PAGE 85

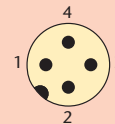

VIEW OF MALE CONNECTOR PLUG H

MODELS NPN/PNP

2 WIRES (EMITTER)

- 1 = Brown / +
- 3 = Blue / -

4 WIRES (OTHER MODELS)

- 1 = Brown / +
- 3 = Blue / -
- 4 = Black / output NPN-PNP/N.O.
- 2 = White / output NPN-PNP/N.C.

MODELS RELAY

2 WIRES (EMITTER)

- 1 = Brown / +
- 3 = Blue / -

4 WIRES (OTHER MODELS)

- 1 = Brown / +
- 3 = Blue / -
- 2-4 = Relay contact

N.B. With relay in OFF position the contact 2-4 is open. With connectors with cable the contact 2-4 corresponds to the Black-White wiring.

*The sensing distance is related to matt white paper dim. 20 x 20 cm. **The sensing distance is related to CT80 reflector.

Meyer Industrie-Electronic GmbH – MEYLE

Carl-Bosch-Straße 8
 49525 Lengerich/Germany
 Internet: www.meyle.de

Tel.: (+49) 054 81/9385-0
 Fax: (+49) 054 81/9385-12
 E-Mail: sales@meyle.de

PHOTOELECTRIC SENSORS FTQ SERIES - RELAY

12 ÷ 240 VAC/DC



COMPACT SIZE 50 x 50 x 18 mm
RELAY OUTPUT
PROGRAMMABLE RELAY ON/OFF
SENSITIVITY ADJUSTMENT

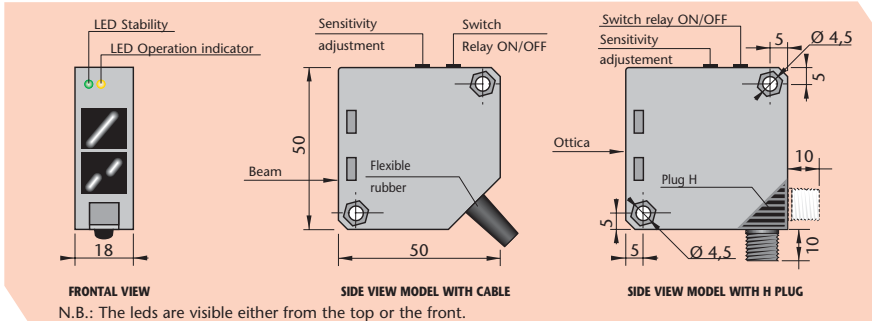

FRONTAL VIEW
N.B.: The leds are visible either from the top or the front.

H PLUG - M12 CONNECTOR

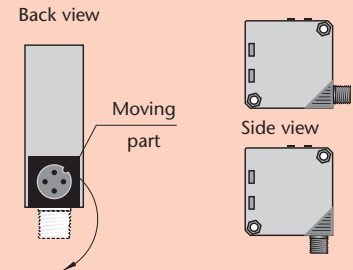

Turn in the clockwise to choose the direction of the connector exit.

TYPES

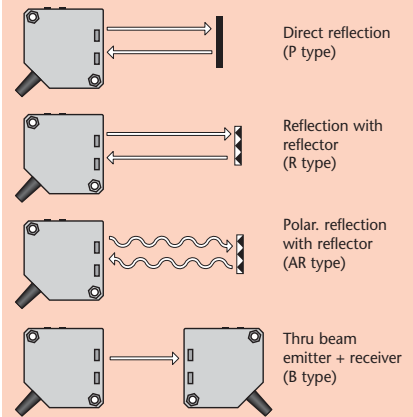

MOUNTING BRACKET ST2

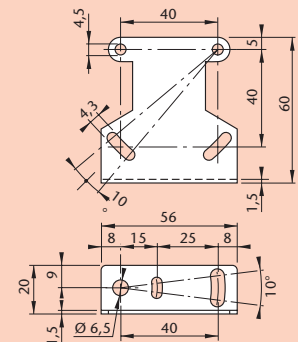

EMITTER FTQ - CBE/FTQ - BE - R

POSITION OF POWER SUPPLY LED

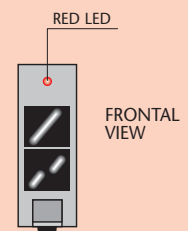

DIRECT REFLECTION	REFLECTION WITH REFLECTOR	POLARIZED REFLECTION WITH REFLECTOR	RECEIVER	THRU BEAM	EMITTER
FTQ-P-R	FTQ-R-R	FTQ-AR-R	FTQ-BR-R		FTQ-BE-R
FTQ-P-R-H	FTQ-R-R-H	FTQ-AR-R-H	FTQ-BR-R-H		FTQ-BE-R-H
80*	500**	300**		2000	
RELAY ON/OFF (Programmable)					
Infrared				Infrared	
≤ 100					
10					
12 ÷ 240					
12 ÷ 240					
Contact relay 1A 220Vac					-
1.8 VA					1 VA
>10.000 Lux					
Operation indicator					Power supply
Stability control					(Red Led)
Working temperature: -20 ÷ +50 / Storage temperature: -20 ÷ +65					
65					
Gray ABS					
5 x 0.35 mm ²				2 x 0.50 mm ²	
H					

INSTRUCTIONS FOR THE PROGRAMMING AND ADJUSTMENT

FTQ MODELS (NPN/PNP)

- GREEN LED - STABILITY INDICATOR:** This led is on when the level of the output signal and the alignment of the photoelectric sensors are in the optimum position. In the case that the led is off this indicates that the lens is obscured or for the types with direct reflection a possible alteration of the dimension or color of the object to be detected.
- YELLOW LED - OPERATION INDICATOR:** This led is on when the object to be detected enters the sensing range of the photocell giving output signals.
- TRIMMER FOR THE SENSING RANGE ADJUSTMENT:** The photocell is supplied with max. sensing range with the trimmer totally rotated in the clockwise direction. The sensitivity reduces by rotating the trimmer in the anti-clockwise direction.
- SWITCH NPN/PNP:** The photocell is supplied with the switch in P (PNP output). To change to NPN turn the switch to N in the clockwise direction.

FTQ MODELS (RELAY)

- SWITCH RELAY ON/OFF:** The photocell is supplied with the switch in OFF (relay de-energized without object). To change to ON (relay energized without object) turn the switch to ON in the clockwise direction.

NOTE! Before giving a power supply to the photocell it is recommended that the same unit be programmed by using the switch in the required function NPN or PNP and NO or NC.

Meyer Industrie-Electronic GmbH - MEYLE

Carl-Bosch-Straße 8
49525 Lengerich/Germany
Internet: www.meyle.de

Tel.: (+49) 05481/9385-0
Fax: (+49) 05481/9385-12
E-Mail: sales@meyle.de